



DATASHEET

TANK BREATHER VALVES FOR BULK STORAGE TANKS

Opti-flow 380 Series (Weight Loaded) Pressure/Vacuum Relief Valves



APPLICATION

Motherwell Tank Protection (MTP) Opti-flow 380 Series direct acting **Pressure/Vacuum Relief Valves**, or **Breather Valves** are special types of relief valves which are specifically designed for tank protection.

The 380 range includes pressure only, vacuum only and combined pressure / vacuum valves, all available with flanged outlets or vented to atmosphere. The valves are compliant with European ATEX directives where applicable.

MTP 380 series valves are used extensively on **bulk storage tanks**, including floating roof tanks. The valves prevent the build up of excessive pressure or vacuum which can unbalance the system or damage the storage vessel.

MTP 380 Series valves are manufactured by MTP in our UK manufacturing plant to exacting quality standards and backed by over 40 years experience. Sizes range from 2" (50mm) to 12" (300mm).

BENEFITS

- **Opti-flow** technology provides **high gas flow** in compact valve size
- Range of **sizes and materials** to suit a wide range of applications
- Wide range of pressure and vacuum settings to provide **maximum tank protection** whilst ensuring minimum gas loss
- **FREE valve sizing** service assists optimum valve performance/cost specification.

PRINCIPLE OF OPERATION

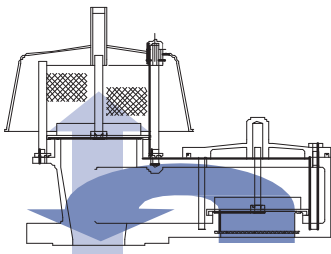

MTP Opti-flow valves have a cast body which is flanged for connection to the storage tank. A weather hood protects the pressure exhaust port and a mesh cover is fitted to prevent the ingress of foreign matter for valves vented to atmosphere. Piped-away versions are also available throughout the range.

Both the pressure and vacuum side of the valve incorporate a pallet and diaphragm assembly which rest on an 'O' ring seal to prevent leakage (Leak tested to API2521). This o-ring can be removed and the seat machined optically flat, producing a metal to metal seating arrangement if required.

The weight of the pallet pushes the diaphragm against the seat to keep it closed. When the pressure or vacuum increases, the pallet and diaphragm lifts, and air / gas is allowed to flow.

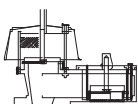

380
Pressure Relief to Atmosphere
Vacuum Relief from Atmosphere

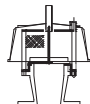

381
Pressure Relief to Atmosphere

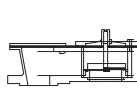

382
Vacuum Relief from Atmosphere

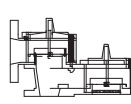

383
Pressure Relief to Closed Line
Vacuum Relief from Atmosphere

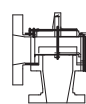

384
Pressure Relief to Closed Line

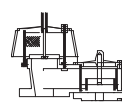

385
Pressure Relief to Atmosphere
Vacuum Relief from Closed Line

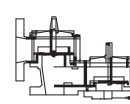

386
Pressure Relief to Closed Line
Vacuum Relief from Closed Line

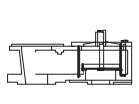

387
Vacuum Relief from Closed Line

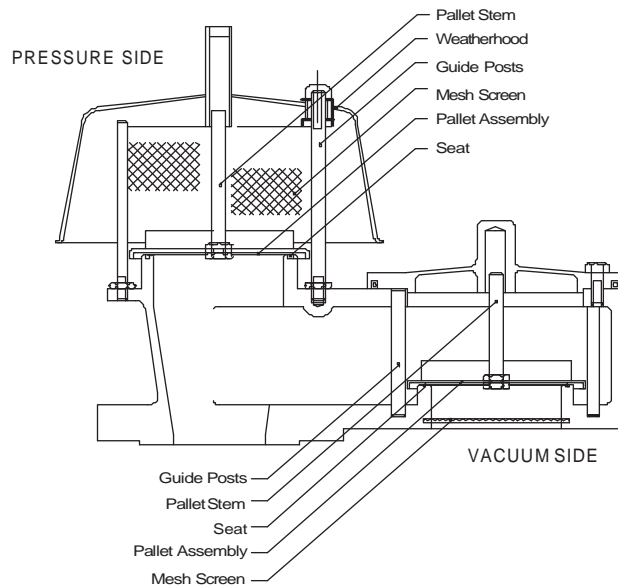

GENERAL DESCRIPTION

MTP Opti-flow 380 Series, Pressure & Vacuum Relief Valves, Tank Breather Valves

APPLICATION

Bulk Storage Tanks, Chemical Tanks, Low pressure gas pipeline systems, Digesters, Gas Holders

PHYSICAL

Model 380, 381, 382, 383, 384, 385, 386, 387

Sizes 2", 3", 4", 6", 8", 10" 12"

Process Connection
 1. ANSI 150# (Standard)
 2. PN16
 3. Special (Flange drilling as required)

Materials
 1. Aluminium
 2. Cast Iron
 3. Carbon Steel
 4. Stainless Steel
 5. Special (Available upon request)

Pallet
 1. Stainless Steel
 2. Aluminium
 3. Special (Available upon request)

O-Ring Seals
 1. PTFE
 2. Nitrile rubber
 3. Viton
 4. Specials (Available upon request)

PROCESS

Pressure & Vacuum Settings Low flow from 0.865"wg (2.15mbar)
 Dead Weight Valves High flow to 30"wg (75mbar)

ORDERING CODE

MODEL-SIZE-PROCESS CONNECTION-MATERIAL-TRIM-SEAL-DIAPHRAGM (+Settings)
 e.g. **380-04-1311** (380 series, 4" ANSI 150# connection, carbon steel body, stainless trim, PTFE o-rings & PTFE diaphragm)

VALVE SIZING – FREE SERVICE

Computerised valve sizing to API 2000, contact us on the numbers below.

AFTERSALESSUPPORT

MTP provide comprehensive spares support, a **free valve inspection service** and term preventative maintenance schemes using product-trained technicians to service MTP and other brands of valves and fittings.

Motherwell Tank Protection

St Michaels Road
 Lea Green Ind Est
 St Helens
 Merseyside

England WA9 4WZ

Tel : + 44 1744 815211

Fax : +44 1744 814497

sales@motherwelltankprotection.co.uk

www.motherwelltankprotection.co.uk



INVESTOR IN PEOPLE

